

E-100-A & E-100-L-A

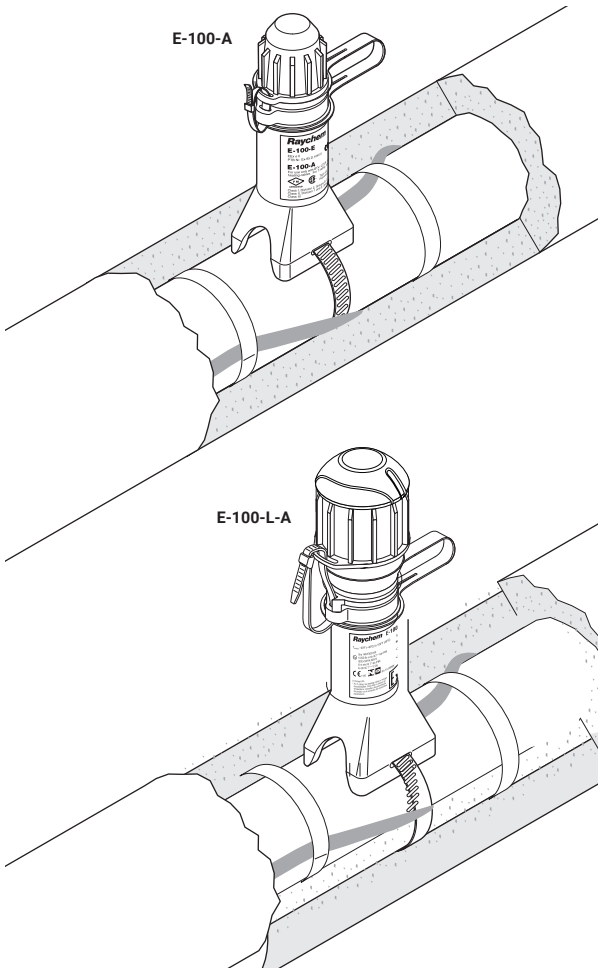

RAYCHEM

END SEAL AND LIGHTED END SEAL KITS



PRODUCT OVERVIEW

The nVent RAYCHEM E-100-A and E-100-L-A serve as above-insulation end seal kits for nVent RAYCHEM brand BTV, QTVR, XTV, KTV, or VPL heating cables. They are approved by FM and CSA for use in hazardous locations.

Both the E-100-A and the E-100-L-A are mounted on the pipe and project through the thermal insulation and cladding for ease of maintenance. The E-100-L-A end seal with signal light uses an array of bright LEDs for exceptional visibility and long product life.

These rugged end seals are made from high-performance engineering polymer and resist impact, high temperature, and chemical and UV exposure. The stand allows for up to four inches (100 mm) of thermal insulation. The encapsulated light and boot reliably prevent moisture and dust ingress. The industrial-grade electronics used in the E-100-L-A are encapsulated.

Both the E-100-A and E-100-L-A are re-enterable, allowing easy access for testing. Voltage and continuity checks can be done by simply unscrewing the E-100-A cap and removing the reusable sealing boot. The E-100-L-A makes maintenance even easier by allowing for visual inspection of heating circuit continuity. The E-100-L-A can be retrofitted into previously installed E-100-A end seals. The light module is replaceable.

The kits contain all the necessary materials for a complete installation except for one pipe strap, which must be ordered separately.



DESCRIPTION

	E-100-A	E-100-L-A
	Above-insulation end seal, cold-applied	Above-insulation end seal with red indicator light, cold-applied *Not for use with 480 V VPL











KIT CONTENTS

Note: Order appropriate pipe strap separately (one per kit)

1 end seal

1 end seal with red indicator light

APPROVALS

E-100-A	E-100-L-A
Hazardous Locations	Hazardous Locations
 Class I, Div. 2, Groups A, B, C, D Class II, Div. 1 and 2, Groups E, F, G Class III  (1)	 Class I, Div. 2, Groups A, B, C, D Class II, Div. 1 and 2, Groups E, F, G Class III  (1)
 CLI, ZN1, AEx e II T ⁽²⁾  Ex e II T ⁽²⁾ IECEx PTB 09.0038U Ex e II Ex tD A21 IP66	 CLI, ZN1, AEx e mb IIC T ⁽²⁾ Gb ZN21 AEx tb IIIC T*  Ex e mb IIC T ⁽²⁾ Gb Ex tb IIIC T* IECEx SIR 14.0007X Ex e mb IIC T* Gb IP66 Ex tb IIIC T***C Db
 09-IEEx-0004X 09-IEEx-0005X 09-IEEx-0006X 09-IEEx-0007X Ex e IIC T* Gb	 09-IEEx-0004X 09-IEEx-0005X 09-IEEx-0006X 09-IEEx-0007X Ex em IIC T* Gb ⁽³⁾
(1) Except VPL (2) For T-rating, see heating cable or design documentation (3) Except KTV-CT * For system Temperature Code, see heating cable or design documentation.	

PRODUCT SPECIFICATIONS

	E-100-A	E-100-L-A
Heating cable capability	BTV-CR, BTV-CT, QTVR-CT, XTV-CT, KTV-CT and VPL-CT	
Ingress protection	Type 4X (IP66)	Type 4X (IP66)
Minimum installation temperature	-40°F (-40°C)	-40°F (-40°C)
Minimum ambient temperature	-75°F (-60°C)	-40°F (-40°C)
Maximum ambient temperature	132°F (56°C)	104°F (40°C)
Maximum pipe temperature	500°F (260°C)	500°F (260°C)
Maximum operating voltage	480 Vac	277 Vac
Overall height	7 in (175 mm)	8 in (200 mm)
Outer diameter at insulation	2 in (50 mm) Usable with up to 4 in (100 mm) thermal insulation	3 in (75 mm)
Materials	High-performance glass-filled engineered polymer	High-performance glass-filled engineered polymer
Light source		Super-bright light-emitting diodes (LEDs), red
Light source power supply	Not applicable	Linear (nonswitching)
Power consumption	N/A	< 2 W

ORDERING DETAILS

	E-100-A	E-100-L-A
End seal		
Catalog number	E-100-A (100–480 Vac)	E-100-L-A (100–277 Vac)
Part number	046567-000	P000001582
Weight	0.6 lb (272 g)	0.65 lb (295 g)

Spare boot pack for E-100

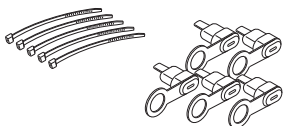

Catalog number	E-100-BOOT-5-PACK
Part number	281053-000
Pack weight	0.25 lb (140 g)
Pack contents	Five sealant-filled boots and five cable ties

Replacement indicator light for E-100-LR-A

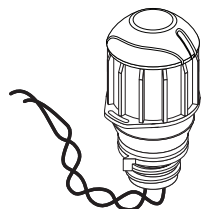

Catalog number	E-100-LR-A (100–277 Vac)
Part number	P000001584
Weight	0.33 lb (150 g)

North America

Tel +1.800.545.6258
 Fax +1.800.527.5703
 thermal.info@nvent.com

Europe, Middle East, Africa

Tel +32.16.213.511
 Fax +32.16.213.604
 thermal.info@nvent.com

Asia Pacific

Tel +86.21.2412.1688
 Fax +86.21.5426.3167
 cn.thermal.info@nvent.com

Latin America

Tel +1.713.868.4800
 Fax +1.713.868.2333
 thermal.info@nvent.com



nVent.com

Our powerful portfolio of brands:

CADDY ERICO HOFFMAN RAYCHEM SCHROFF TRACER